

Project	_____
Location	_____
Quote/Ref #	_____

ARS3-1300RD





3.5" Adjustable Down Light

ARS3-1300RD is a 3.5-inch gear-driven adjustable downlight that features a wide range of functionality, trim styles, trim colors, beam angles and accessories to meet any lighting requirements. Center-beam adjustable design optimizes light output up to 40° tilt with full 360° rotation. Gear-driven mechanism enables hot-aiming capability. Installation is hassle-free and all adjustments including changing trims, optics, and accessories can be done below ceiling after installation. Light engine is removable from flange and flangeless modules after installation to enable field serviceability.

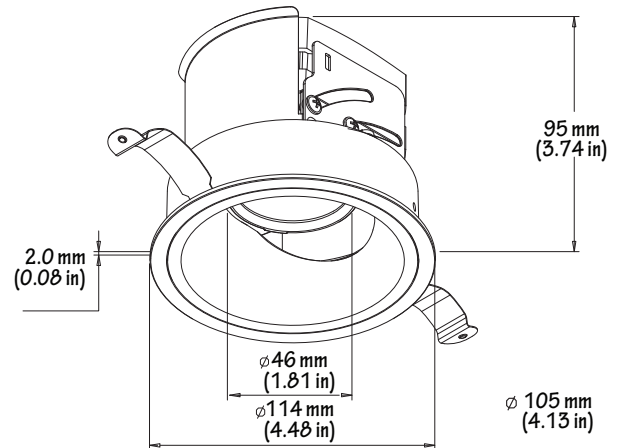

INPUT VOLTAGE	120V AC
POWER CONSUMPTION	17W
DELIVERED OUTPUT	1200 Lumens
COLOR RENDERING	90 CRI
COLOR CONSISTENCY	3 SDCM
BEAM SPREAD	Spot 17° Medium 24° Wide 39°
LUMEN MAINTENANCE	50,000 Hrs
CONTROL FEATURE	TRIAC ELV / 0-10V / DALI
COLOR TEMPERATURE	Overload & Short circuit protection
OPTICS	27K / 30K / 35K / 40K
TRIM FINISHES	Spot 17° / Medium 24° / Wide 39°
TRIM STYLE	Black / White / Blue / Gold / Haze
CUTOUT	Bevel / Pinhole / Angle Cut
MATERIAL	∅105mm (4.13")
TRIM SHAPE	Machine grade aluminum
LENS	ROUND
CERTIFICATION	Interchangeable optics
RATING	RoHS compliant
	Dry, damp & wet location



	COLOR TEMP	CRI	LUMENS
	2700K	90	1200
	3000K	90	1200
	3500K	90	1200
	4000K	90	1200



COLLAR



FF
Flanged Collar



LF
Flangeless Collar

TRIMS



ARS1301
Beveled Deep

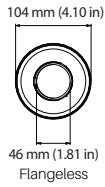
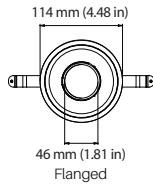

ARS1302
Beveled
(wet location)

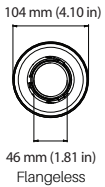
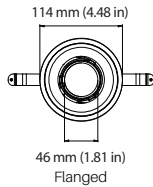

ARS1303
Pinhole
(wet location)

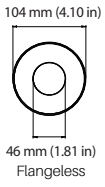
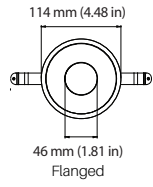

ARS1304
Angle Cut

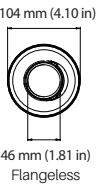
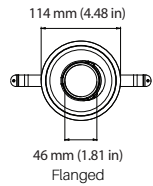

ARS1305
Wall Wash

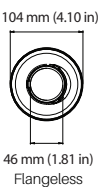
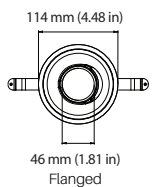

HOUSING

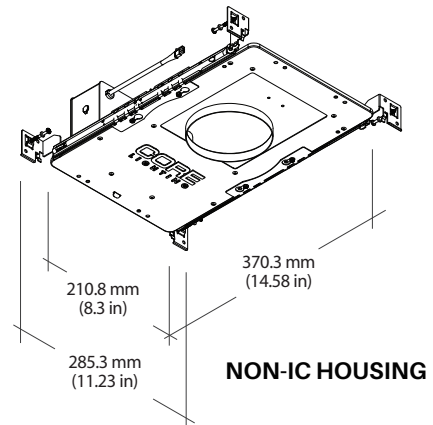
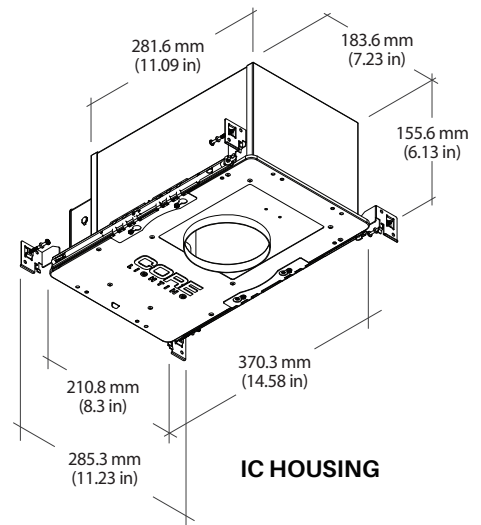

STANDARD ORDERING CODE

LIGHT ENGINE

Model	Ceiling Appearance	Output	Color Temp	Beam Angle	Type	Driver	Voltage
ARS3-1300RD Round	LF Flangeless	L2 Low Output (17W)	27K 2700K	17 Spot 17°	ADJ Adjustable	STD Standard Phase 1% 0-10V Dimming	UNV/010 120V-277V
	FF Flanged		30K 3000K	24 Medium 24°	FXD Fixed	HL2W Lutron Hi-Lume 1% 2 Wire	
			35K 3500K	39 Wide 39°		HLECO Lutron Hi-Lume 0.1% Ecosystem	
			40K 4000K				
			18-30K 1800K-3000K (WARM-DIM)				

note: 277V only dims with 0-10

HOUSING

Model	Rating
ARS3-1300RD-HS	IC IC rated
	N Non-IC rated

TRIM

Model	Trim Style	Trim Color
ARS3 Round	1301RD-BD - Beveled Deep	WH - White
	1302RD-BV - Beveled (wet location)	BK - Black
	1303RD-PH - Pin Hole (wet location)	
	1304RD-AC - Angle Cut	
	1305RD-WW - Wall Wash	

PHOTOMETRICS

Round | 17W | 90CRI | 3000K | Angle cut trim

Tilt 0°

Spot 17°

Delivered Output : 1174 lm | CBCP : 5051 cd | Beam Angle : 22°

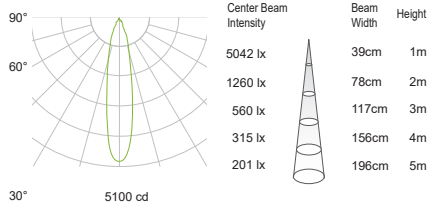

Tilt 20°

Spot 17°

Delivered Output : 1178 lm
CBCP : 4926 cd

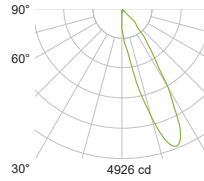

Tilt 40°

Spot 17°

Delivered Output : 1048 lm
CBCP : 4750 cd

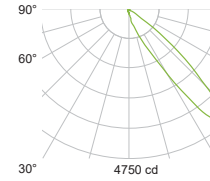

Medium 24°

Delivered Output : 1156 lm | CBCP : 3336 cd | Beam Angle : 30.6°

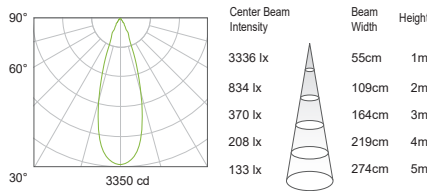

Medium 24°

Delivered Output : 1178 lm
CBCP : 3361 cd

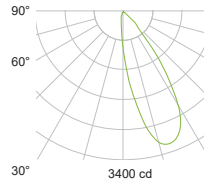

Medium 24°

Delivered Output : 1070 lm
CBCP : 3183 cd

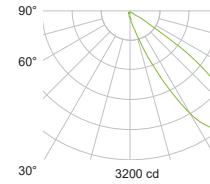

Wide 39°

Delivered Output : 1152 lm | CBCP : 2143 cd | Beam Angle : 42°

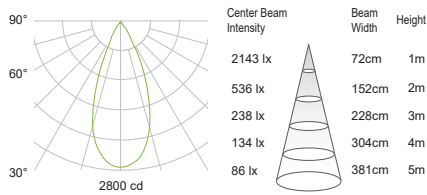

Wide 39°

Delivered Output : 1104 lm
CBCP : 2143 cd

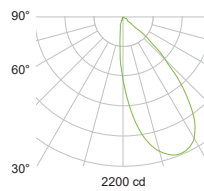

Wide 39°

Delivered Output : 1022 lm
CBCP : 2141 cd

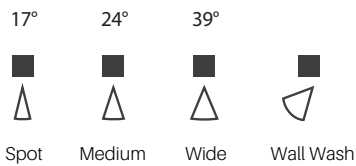
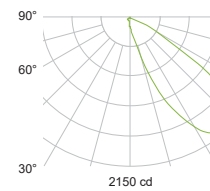

ASSEMBLY

