

# ARS3-1300RD

## 3.5" ADJUSTABLE DOWNLIGHT

Project \_\_\_\_\_  
Location \_\_\_\_\_  
Quote/ Ref # \_\_\_\_\_

**ARS3-1300RD** is a 3.5-inch gear-driven adjustable downlight that features a wide range of functionality, trim styles, trim colors, beam angles and accessories to meet any lighting requirements. Center-beam adjustable design optimizes light output up to 40° tilt with full 360° rotation. Gear-driven mechanism enables hot-aiming capability. Installation is hassle-free and all adjustments including changing trims, optics, and accessories can be done below ceiling after installation. Light engine is removable from flange and flangeless modules after installation to enable field serviceability.



### SPECIFICATIONS

INPUT VOLTAGE	120-277V AC
POWER CONSUMPTION	17W
LUMEN OUTPUT	1200 Lumens
CRI	90 CRI
BEAM ANGLE	Spot 17°   Medium 24°   Wide 39°
CONTROL	TRIAC ELV / 0-10V / DALI
COLOR TEMPERATURE	27K / 30K / 35K / 40K / 18-30K
TRIM SHAPE	Round
TRIM FINISHES	Black / White
TRIM STYLE	Bevel / Pinhole / Angle Cut / Wall Wash
CERTIFICATION	UL Listed
LUMEN MAINTENANCE	50,000 Hrs

### FEATURES

- 17W
- 3 SDCM Color Consistency
- Overload and Short Circuit Protection
- Ø105mm (4.13") cutout
- Interchangeable Optics
- Machine Grade Aluminum
- Dry, damp & wet location
- IC and Non-IC Rated Housing options
- UL Listed (US and Canada)



MODEL	CEILING	OUTPUT	COLOR TEMP	BEAM ANGLE	TYPE	DRIVER	VOLT
ARS3-1300RD	LF Flangless	L2 Low Output (17W)	27K 2700K	17 Spot 17°	ADJ Adjustable	STD Standard Phase 1% 0-10 Dimming	UNV/010 120V-277V
	FF Flanged		30K 3000K	24 Medium 24°			
			35K 3500K	39 Wide 39°			
			40K 4000K				
			18-30K 1800K-3000K (Warm-Dim)				
					HL2W Lutron Hi-Lume 1% 2 Wire		
					HLECO Lutron Hi-Lume 0.1% Ecosystem		

\*277V Dimming on 0-10 only

# ARS3-1300RD

## 3.5" ADJUSTABLE DOWNLIGHT

### DIMENSIONS

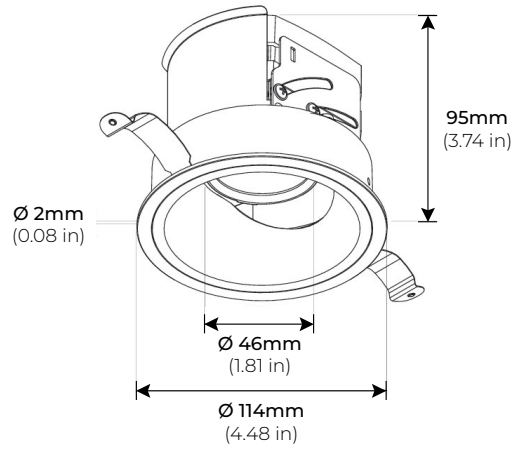

### COLLAR

**FF**  
FLANGED COLLAR



**LF**  
FLANGELESS COLLAR



### TRIMS

#### BEVELED DEEP

**ARS3-1301-BD-RD-WH**  
WHITE ROUND BEVELED DEEP TRIM

**ARS3-1301-BD-RD-BK**  
BLACK ROUND BEVELED DEEP TRIM

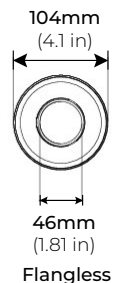
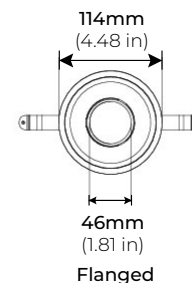

\* Not compatible with Flangeless Collar (LF)  
\* Not compatible with Adjustable Type (ADJ)

# ARS3-1300RD

## 3.5" ADJUSTABLE DOWNLIGHT

### TRIMS

#### BEVELED DEEP (WET LOCATION)

ARS3-1302-BV-RD-WH  
WHITE ROUND BEVELED WET LOCATION TRIM

ARS3-1302-BV-RD-BK  
BLACK ROUND BEVELED WET LOCATION TRIM

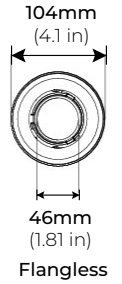
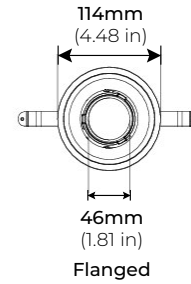

#### PINHOLE (WET LOCATION)

ARS3-1303-PH-RD-WH  
WHITE ROUND WET LOCATION PINHOLE TRIM

ARS3-1303-PH-RD-BK  
BLACK ROUND WET LOCATION PINHOLE TRIM

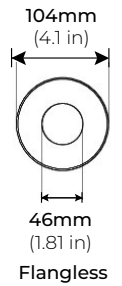
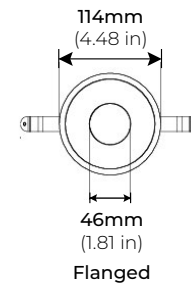

#### ANGLE CUT

ARS3-1304-AC-RD-WH  
WHITE ROUND ANGLE CUT TRIM

ARS3-1304-AC-RD-BK  
BLACK ROUND ANGLE CUT TRIM

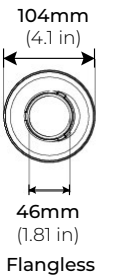
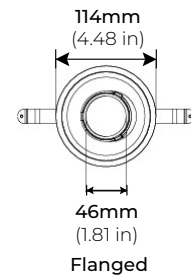

#### WALL WASH

ARS3-1305-WW-RD-WH  
WHITE ROUND WALL WASH TRIM

ARS3-1305-WW-RD-BK  
BLACK ROUND WALL WASH TRIM

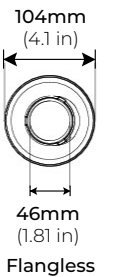
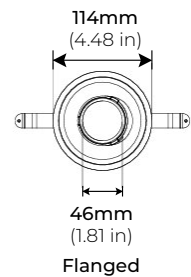

# ARS3-1300RD

## 3.5" ADJUSTABLE DOWNLIGHT

### HOUSING

**ARS3-1300RD-HS-IC**  
IC RATED

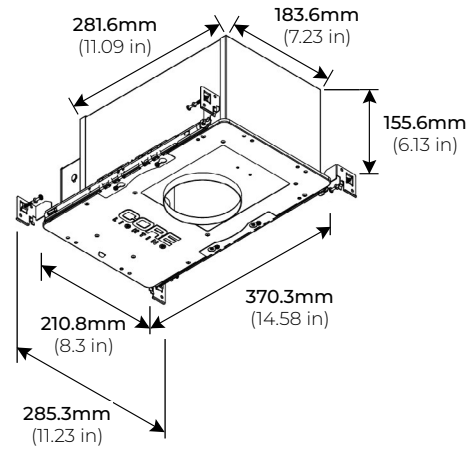

**ARS3-1300RD-HS-N**  
NON-IC RATED

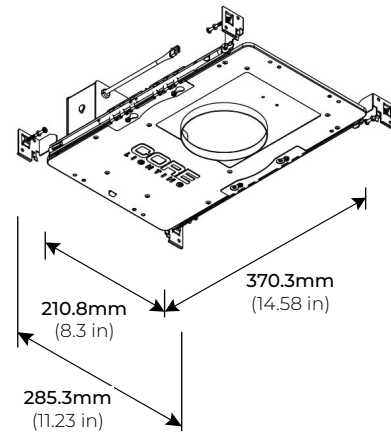

# ARS3-1300RD

## 3.5" ADJUSTABLE DOWNLIGHT

UPDATED: 01.27.26

### PHOTOMETRICS

#### SPOT 17°

ROUND | 17W | 90CRI | 3000K | ANGLE CUT TRIM

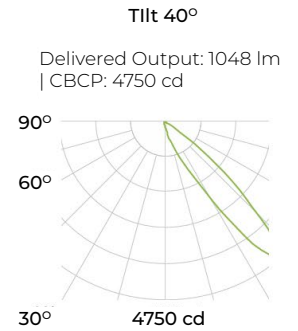
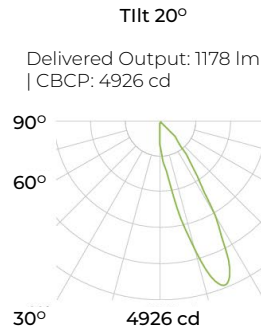
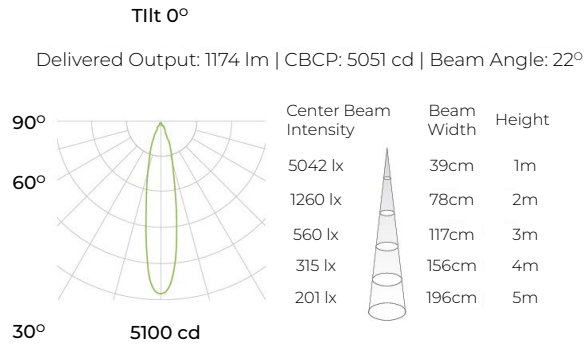

#### MEDIUM 24°

ROUND | 17W | 90CRI | 3000K | ANGLE CUT TRIM

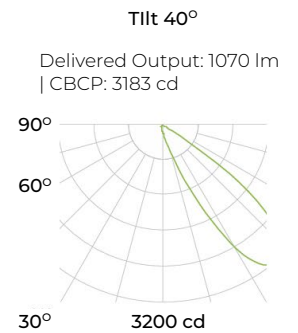
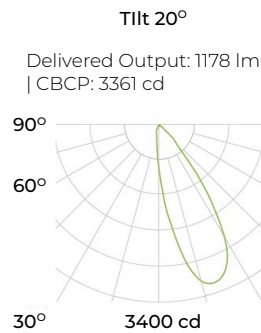
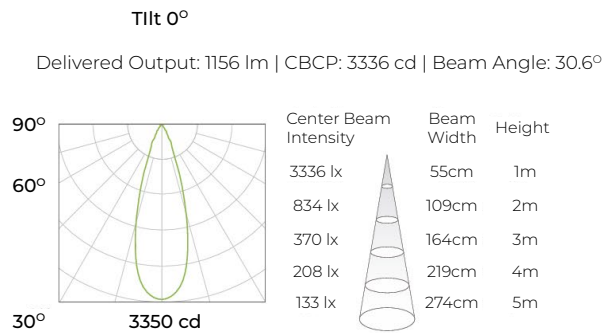

#### WIDE 39°

ROUND | 17W | 90CRI | 3000K | ANGLE CUT TRIM

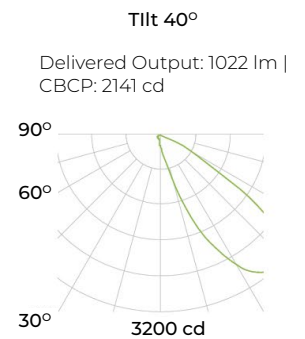
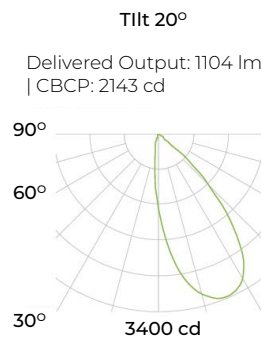
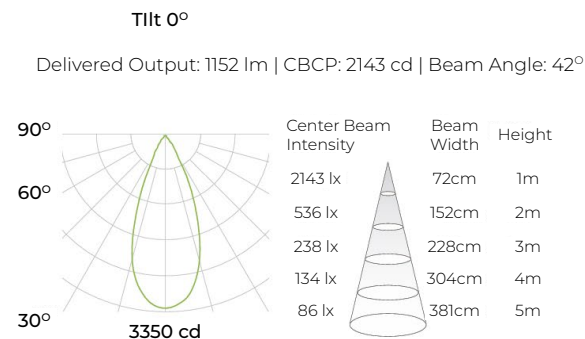

# ARS3-1300RD

## 3.5" ADJUSTABLE DOWNLIGHT

### ASSEMBLY

